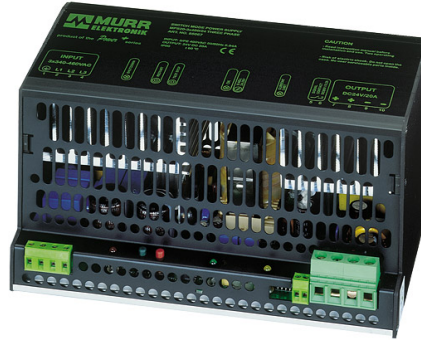

MPS Power supply 3-phase, primary switched IN: 360-550VAC OUT: 22-28V/10ADC

INPUT: 3 × 360...550 V AC

OUTPUT: 22...28 V DC

Current: 10 A

Image

- Units decoupling through diode block at parallel usage.

- stable output voltage, short-circuit and overload protected

- Wide voltage input

- touch protected (EN 60529) IP20

Vicarious picture

Approvals**Input**

Voltage range	3 × 360...550 V AC
Input current	3 × 0.41 A
Primary fusing	max. 10 A
Frequency	50/60 Hz

Output

Output voltage	24 V DC (SELV), ±1 %; 22...28 V adjustable
Output current	10 A (+60 °C); 12 A (+40 °C) 90 %
Mains failure bridging	>= 3 ms (400 V AC)
Ripple	<= 20 mV rms
Spikes	<= 100 mV p-p
Protection	short-circuit and overload protected, pre-warning and switching-off when overheated or overloaded, signaling over alarm output
Phase monitoring	Switching off during 2-phase operation
LED display	LED (green): in operation; LED (red): off; LED (yellow): pre-warning when overheated or overloaded
Parallel usage/ serial usage	yes/yes

General data

Standards	(EN 60950-1), (EN 61204-3), (EN 55022 B)
Temperature range	0...+60 °C (storage temperature -25...+85 °C)
Mounting method	DIN-rail mountable TH35 (EN 60715), additional plate for screw mounting Art.-No. 89500
Relative humidity	30...90 %, no condensation
Dimensions H × W × D	132 x 198 x 97 mm

All data on this data sheet was compiled carefully.

Liability regarding correctness, completeness, and actuality is limited to gross negligence. Created: 06/12

Commercial data

Net weight	2045
Net weight	2045
Weight unit	gram
Basic unit	pc.
Customs tariff number	85044090
Unit (piece)	1
Limited value	1

Comments

This switch mode power supplies meet the (EN 61000-3-2) standard for harmonic current.

Circuit diagram

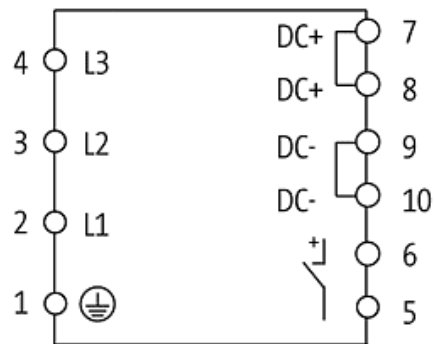

Dimension drawing

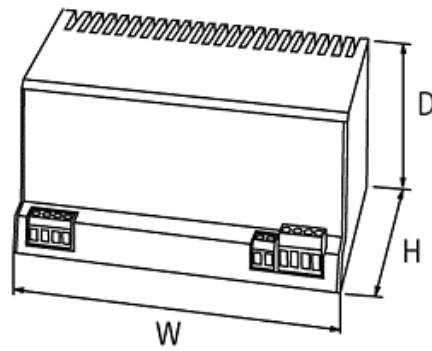

Representante oficial de:



[Argentina – Uruguay – Paraguay – Bolivia – Colombia – y Perú.]



Calle 49 N° 5764 - Villa Ballester (B1653AOX) - Prov. de Buenos Aires - ARGENTINA
Tel: (+54 11) 4768-4242 / Fax: (+54 11) 4849-1212
Mail: ventas@nakase.com.ar / Web: www.nakase.com.ar

