

MCS Power supply 2-phase, primary switched IN: 340-460VAC OUT: 24-28V/5ADC

INPUT: 340...460 V AC

OUTPUT: 24...28 V DC

Current: 5 A

Image

- 1-/2-phase, primary switched
- stable output voltage, short-circuit and overload protected
- touch protected (EN 60529) IP20

Vicarious picture

Approvals**Input**

Voltage range	340...470 V AC
Input current	0.85 A (400 V AC)
Inrush current after 1 ms	<= 22 A
Primary fusing	max. 10 A
Frequency	50/60 Hz

Output

Output voltage	24 V DC (SELV), $\pm 1\%$; 24...28 V adjustable
Output current	5 A (+60 °C); 6 A (+40 °C)
	86 %
Mains failure bridging	>= 10 ms (400 V AC)
Ripple	<= 20 mV rms
Spikes	<= 100 mV p-p
Protection	Short-circuit and overload protected
LED display	LED (green) for output voltage
Selectable switch-off mode	front sided plug link (automatic re-start or definite shut-off)
Parallel usage/serial usage	max. 5 units/max. 2 units

General data

Standards	(EN 60950-1), (EN 61204-3), (EN 55022 B)
Mounting method	DIN-rail mountable TH35 (EN 60715)
Relative humidity	5...95 %, no condensation
Temperature range	0...+60 °C (storage temperature -25...+85 °C)
Dimensions H x W x D	127 x 68 x 140 mm

Commercial data

Net weight	800
Net weight	800
Weight unit	gram
Basic unit	pc.
Customs tariff number	85044090
Unit (piece)	1
Limited value	1

Accessories

Accessory for MCS Plate for screw mounting

Art.-No.

89514

All data on this data sheet was compiled carefully.

Liability regarding correctness, completeness, and actuality is limited to gross negligence. Created: 06/12

Circuit diagram

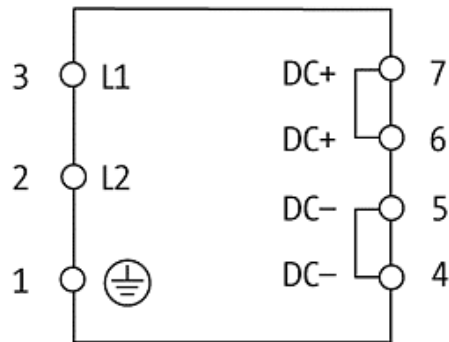

Dimension drawing

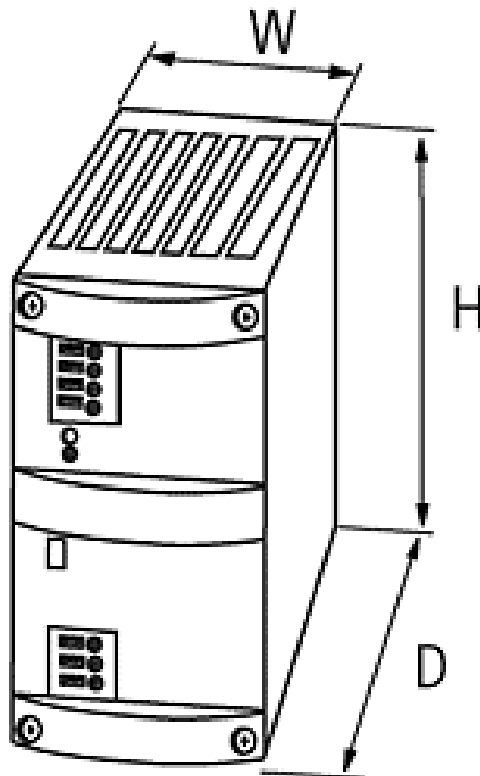

Representante oficial de:



[Argentina – Uruguay – Paraguay – Bolivia – Colombia – y Perú.]



Calle 49 N° 5764 - Villa Ballester (B1653AOX) - Prov. de Buenos Aires - ARGENTINA
Tel: (+54 11) 4768-4242 / Fax: (+54 11) 4849-1212
Mail: ventas@nakase.com.ar / Web: www.nakase.com.ar

